

LUNE by **CONFIDENCE AND LIGHT**

LUNE









APPLIQUE, BANDEAU, CORNICHE

WALL-MOUNTED LUMINAIRE, STRIP LIGHT, CORNICE LIGHT

DESCRIPTION / DESCRIPTION

- Éclairage indirect/direct
- 2 lampes fluorescentes compactes (36, 55 ou 80 W) ou 2 tubes fluorescents (28, 35, 54 ou 80 W)
- Ballast électronique dimmable
- Film optique d'uniformisation du flux & perforation basse luminance à maille carrée pour la diffusion directe
- Verre trempé anti-poussière
- Opaline décorative
- *Indirect/direct light emission*
- *2 compact fluorescent lamps (36, 55 or 80 W) or 2 fluorescent tubes (28, 35, 54 or 80 W)*
- *Dimmable HF electronic control gear*
- *Optical film inlay for defined light distribution & low luminance perforation with square mesh for direct diffusion*
- *Anti-dust hardened float glass*
- *Decorative opal glass*

LES FINITIONS / FINISHES

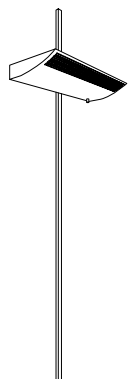
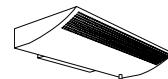
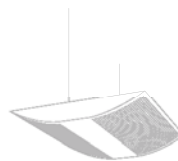
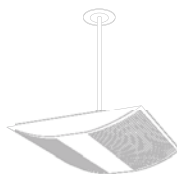
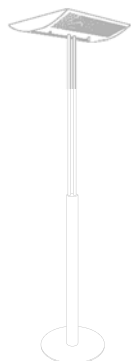

- Blanc satiné 
- Argent 9006 satiné 
- Autres couleurs sur demande
- Opalines      
- *Powder coated satin white*
- *Powder coated satin silver (9006)*
- *Other colours on request*
- *Decorative opal glasses*



LES VERSIONS / VERSIONS

- Appliques murales
- Bandeaux avec mise en jonction ou isolés
- Appliques sur mâts techniques
- Adaptation sur mobilier
- Corniches (fixation directe sur la paroi sans boîtier mural)
- Éclairage indirect seul
- *Wall-mounted*
- *Strip lights (joined together or isolated)*
- *Mounting on power poles*
- *Adaptations on furniture*
- *Cornice lights (direct fixing on the wall without wall box)*
- *Indirect light emission only*

LES OPTIONS / OPTIONS

- Commande à distance radio 
- Détection de présence/capteur de luminosité EcoDim 
- Commande par boîtier déporté 
- *Radio transmission technology*
- *EcoDim sensor/light sensitive cell*
- *Remote control*

APPLICATIONS SPÉCIFIQUES / SPECIFIC APPLICATIONS

- Éclairage Tertiaire
- Circulations
- Chambres maisons de retraite
- Centres d'appels : appliques sur mâts techniques
- *Office lighting*
- *Corridors*
- *Rooms in retirement homes*
- *Call centers (on power poles)*



LUNE FICHE TECHNIQUE

TECHNICAL DATA SHEET

DIMENSIONS / DIMENSIONS

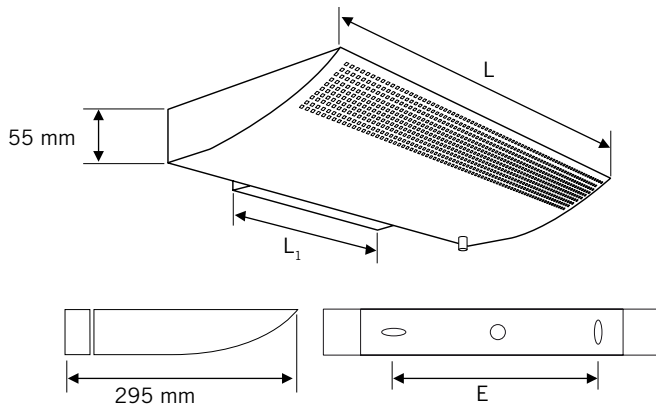

Appliques - Bandeaux / Wall-mounted luminaires - Strip lights
(with interface box on the wall)

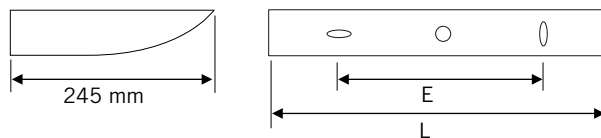

Corniches (fixation directe sur la paroi sans boîtier mural)
Cornice lights (Mounting directly on the wall without wall box)

LES RÉFÉRENCES / ARTICLE NUMBER



Désignation Description	Référence Article number	Équipement Equipment	Culot Lampholder	Longueur Length mm (L)	Boîtier mural Wall box mm (L1)	Nombre points fixation / Number of fixing points	Entraxe entre les points de fixation / Distance between the points - mm	Poids Weight (kg)
Appliques lampes fluorescentes Wall-mounted luminaire Fluorescent lamp	A.LN.236...	2X36 W	2G11	490	300	2	246	5
	A.LN.255...	2X55 W	2G11	590	300	2	246	5
	A.LN.280...	2X80 W	2G11	630	300	2	246	6
Appliques tubes fluorescents Wall-mounted luminaire Fluorescent tube	A.LN.228...	2X28 W	G5	1334	980	5	222	10
	A.LN.235...	2X35 W	G5	1634	980	5	222	11
	A.LN.254...	2X54 W	G5	1334	980	5	222	10
	A.LN.280.G5...	2X80 W	G5	1634	980	5	222	11



Interface de jonction Set for linear mounting A.LN.JX...

Bandeau Strip lights B.LN....

Corniche Cornice Lamps CL.LN...

PHOTOMÉTRIE & NORMES PHOTOMETRY & STANDARDS

- Classe 1  IP 20 850° 
- NF-EN 60.598-1 Luminaires
Règles générales et généralités sur les essais
- NF-EN-60.598-2.1 Luminaires
Règles particulières section un - luminaires fixes à usage général

- Class 1  IP 20 850° 
- NF-EN 60.598-1 - luminaires
General rules and general points about the tests
- NF-EN-60.598-2.1 luminaires
Special rules section one - fixed luminaires for general use

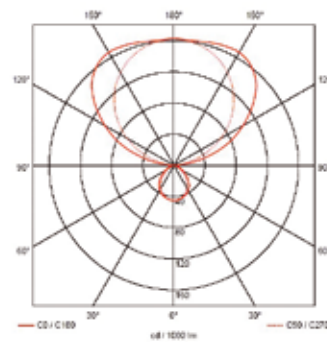

CONFIDENCE AND LIGHT

www.confidenceandlight.com

Siège Social

3, rue Boch - BP 41
45240 La Ferté Saint-Aubin France
Tél. + 33 (0)2 38 76 67 75 Fax + 33 (0)2 38 49 63 82
contact@confidenceandlight.com

Agence Paris

86, rue du Cherche-Midi 75006 Paris France
Tél. + 33 (0)1 42 22 35 35 Fax + 33 (0)1 42 22 35 36
paris@confidenceandlight.com