



**LESS** by **CONFIDENCE** AND LIGHT

# LESS

LUMINAIRES SUR PIED / *FREESTANDING UPLIGHTER*  
DESIGN MICHEL BERTREUX

## DESCRIPTION / DESCRIPTION

- Éclairage indirect/direct
  - Vasque rectangulaire surplombant le plan de travail sur mât rectangulaire
  - Socle rectangulaire
  - 2 ou 3 lampes fluorescentes compactes (55 ou 80 W)
  - Ballasts électroniques dimmables DALI
  - Filtre optique CLEARTECH ®
  - Commande par radio fréquence ou détecteur de présence-capteur de luminosité EcoDim
  - Réflecteurs haut rendement en inox polimiroir
  - Cordon d'alimentation de 3,50 m terminé par prise euro 2P+T
- 
- *Indirect/direct light emission*
  - *Rectangular head overhanging the work surface on rectangular profile*
  - *Rectangular base*
  - *2/3 fluorescent compact lamps (55 or 80 W)*
  - *HF electronic control gear DALI*
  - *CLEARTECH ® optical filter*
  - *Control by radio transmission technology or EcoDim sensor/light sensitive cell*
  - *Stainless steel reflectors*
  - *3.50 m main cable with euro plug*



## LES FINITIONS / FINISHES

- Blanc RAL 9002 
  - Autres couleurs sur demande
- 
- *White RAL 9002*
  - *Other colours on request*

## LES VERSIONS / VERSIONS

- Commande Radio 
  - Commande EcoDim 
- 
- *Radio control*
  - *EcoDim control*

## APPLICATIONS SPÉCIFIQUES / SPECIFIC APPLICATIONS

- Éclairage Tertiaire (Espaces Ouverts & bureaux cloisonnés)
  - Bureaux de Directions
- 
- *Office areas (open spaces & individual offices)*
  - *Management offices*

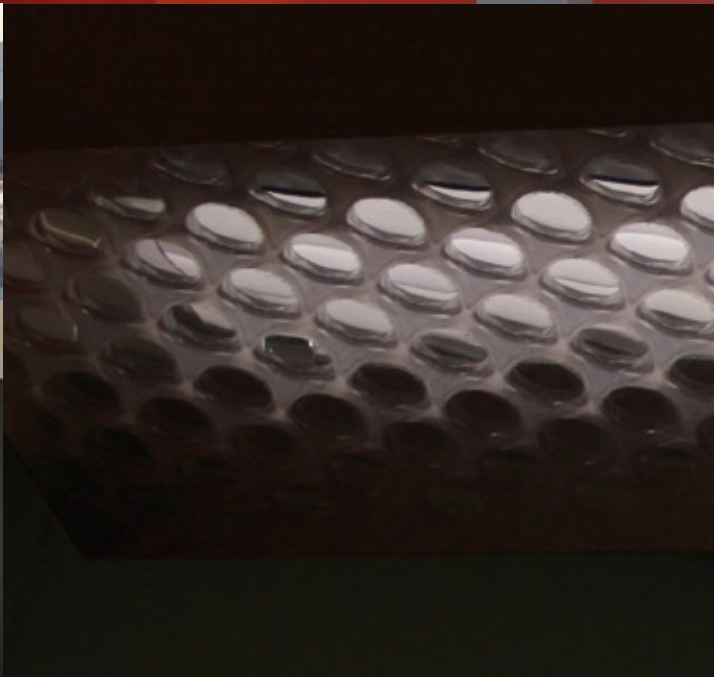



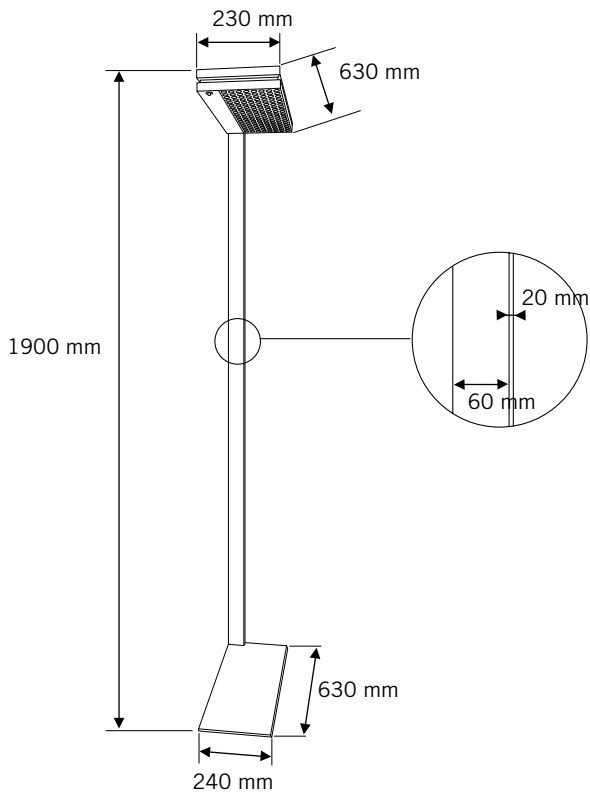

# LESS FICHE TECHNIQUE

TECHNICAL DATA SHEET

## DIMENSIONS / DIMENSIONS



## PHOTOMÉTRIE & NORMES PHOTOMETRY & STANDARDS

- Classe 1  IP 20 850° 
- NF-EN 60.598-1 Luminaires  
Règles générales et généralités sur les essais
- NF-EN-60.598-2.4 Luminaires  
Règles particulières pour les luminaires portatifs à usage général
  
- Class 1  IP 20 850° 
- NF-EN 60.598-1 - luminaires  
General rules and general points about the tests
- NF-EN-60.598-2.4 luminaires  
Special rules for portable luminaires for general use

## LES RÉFÉRENCES / ARTICLE NUMBER

Désignation Description	Référence Article number	Équipement Equipment	Culot Lampholder 	Poids Weight (kg)
Luminaires sur pied Freestanding Uplighter	L.LESS.255	2X55 W	2G11	20
	L.LESS.355	3X55 W	2G11	20
	L.LESS.280	2X80 W	2G11	20
	L.LESS.380	3X80 W	2G11	20

## CONFIDENCE AND LIGHT

[www.confidenceandlight.com](http://www.confidenceandlight.com)

### Siège Social

3, rue Boch - BP 41  
45240 La Ferté Saint-Aubin France  
Tél. + 33 (0)2 38 76 67 75 Fax + 33 (0)2 38 49 63 82  
contact@confidenceandlight.com

### Agence Paris

86, rue du Cherche-Midi 75006 Paris France  
Tél. + 33 (0)1 42 22 35 35 Fax + 33 (0)1 42 22 35 36  
paris@confidenceandlight.com